

Environmental Product Declaration



In accordance with ISO 14025 and EN 15804:2012+A2:2019 for

Kerto[®] LVL

Laminated Veneer Lumber



Programme: The International EPD® System,
www.environdec.com

Programme operator: EPD International AB

EPD registration number: S-P-02802

Publication date: 2022-01-21

Valid until: 2027-01-21

An EPD should provide current information and may be updated if conditions change. The stated validity is therefore subject to the continued registration and publication at www.environdec.com.

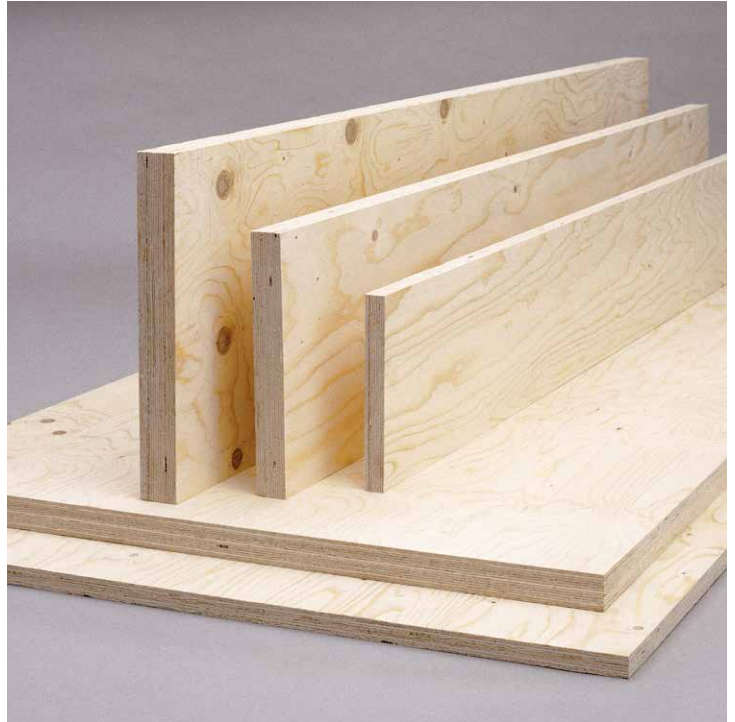

General information

Programme: The International EPD® System

Address: EPD International AB, Box 210 60, SE-100 31 Stockholm, Sweden

Website: www.environdec.com

E-mail: info@environdec.com

CEN standard EN 15804 serves as the Core Product Category Rules (PCR)

Product category rules (PCR): PCR 2019:14 Construction products, Version 1.1 (2020-09-14)

C-PCR-006 (To PCR 2019:14) Version: 2019-12-20

PCR review was conducted by: The Technical Committee of the International EPD® System. The review panel may be contacted via info@environdec.com.

Independent third-party verification of the declaration and data, according to ISO 14025:2006:

EPD process certification EPD verification

Third party verifier: Yannick Le Guern, ELYS Conseil

In case of recognised individual verifiers:

Approved by: The International EPD® System

Procedure for follow-up of data during EPD validity involves third party verifier:

Yes No

The EPD owner has the sole ownership, liability, and responsibility for the EPD.

EPDs within the same product category but from different programmes may not be comparable. EPDs of construction products may not be comparable if they do not comply with EN 15804. For further information about comparability, see EN 15804 and ISO 14025.

Company information

Owner of the epd:	Metsäliitto Cooperative, Metsä Wood P.O.Box 24 08101 Lohja Finland www.metsawood.com	
Description of the organisation:	<p>Metsä Wood is one of Europe's leading manufacturers of engineered wood products. We process valuable log wood into environmentally friendly products for the construction and transport industries, which are both megatrend-driven businesses of the future. Our main products are Kerto® LVL, birch plywood and spruce plywood. Material-efficient wood products store carbon and play an important role in combating climate change.</p> <p>Metsä Group leads the way in the bioeconomy. Metsä Group invests in growth, developing bioproducts and a fossil free future. The raw material for our products is renewable wood from sustainably managed northern forests. Metsä Group focuses on the growth sectors of the forest industry: wood supply and forest services, wood products, pulp, fresh fibre paperboards, and tissue and greaseproof papers.</p> <p>Metsä Group consists of Metsäliitto Cooperative, its two businesses Metsä Wood and Metsä Forest, and its subsidiaries Metsä Tissue, Metsä Board and Metsä Fibre. Metsäliitto Cooperative is the parent company of Metsä Group. It is owned by around 100,000 forest owners.</p> <p>Metsä Group stands out from the competition because of its ownership base and business structure, which also give its operations a long-term perspective. Through Metsäliitto Cooperative's owner-members, Metsä Group has access to a considerable reserve of premium-quality raw material, which provides a stable, long-term foundation for the development of its operations and production plants.</p>	
Product-related or management system-related certifications:	<p>Metsä Forest, part of Metsä Group, is the only wood supplier for Metsä Wood mills in Finland. Metsä Forest, as well as Metsä Wood's Lohja and Punkaharju LVL mills, have PEFC and FSC® Chain of Custody certificates. Metsä Wood mills have certified management system including ISO 9001 quality management, ISO 14001 environmental management, ISO 45001 health and safety management and EES+ energy efficiency system standards. The EES+ system will be replaced by ISO 50001 energy management system during 2021.</p> <p>Metsä Forest fulfils the obligations of European Union Regulation No. 995/2010 (EU Timber Regulation), UK Timber Regulation, US Lacey Act and Australian Illegal Logging Prohibition Act, which all prohibit placing on market and trading of illegally harvested timber and timber products. As all the wood raw material is covered by Chain of Custody certification, all the used wood is traceable and comes from certified or controlled forests. The PEFC logo on the product ensures that 100% of the wood raw material is legally harvested, and at least 70% is sourced from certified forests.</p> <p>PEFC Logo Licence Registration number: PEFC/02-31-03 FSC Licence Code: FSC-CO14476</p>	
Name and location of production sites:	Metsä Wood Lohja Kerto LVL Mill Tehtaankatu 1 08100 Lohja Finland	Metsä Wood Punkaharju Kerto LVL Mill Tehtaantie 18 58500 Punkaharju Finland

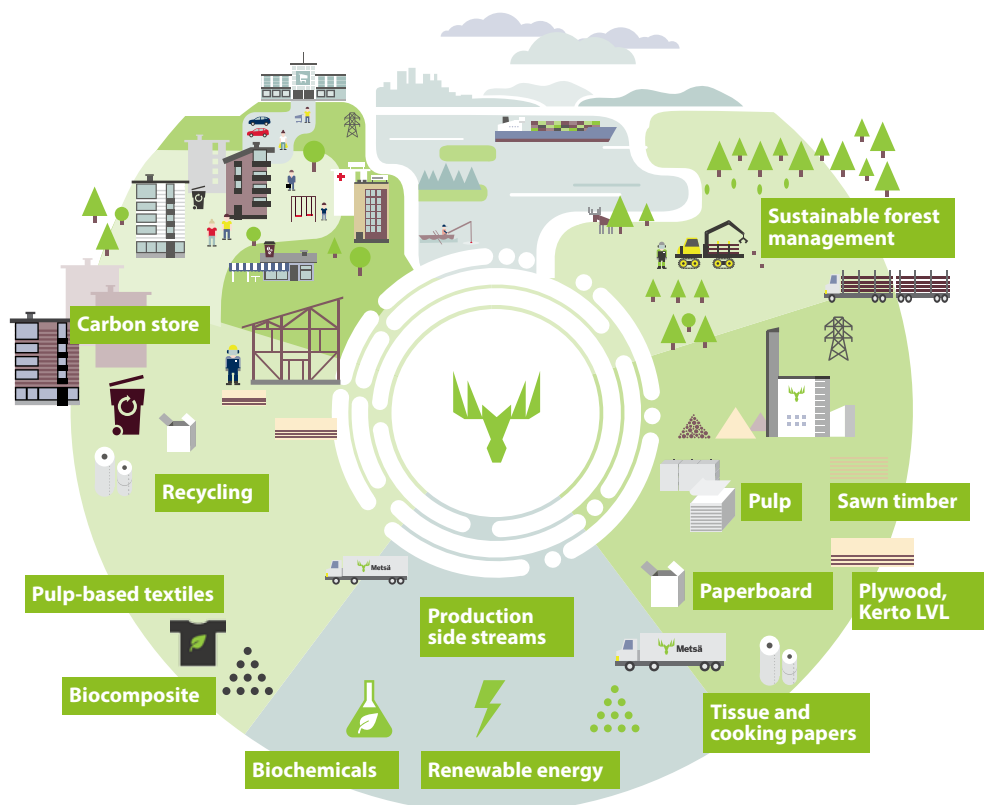

Product information

Product name:	Kerto LVL
Product identification:	<ul style="list-style-type: none"> • Kerto LVL S-beam • Kerto LVL Q-panel • Kerto LVL Qp-beam • Kerto LVL T-stud • Kerto LVL L-panel • Kerto LVL Kate
Product description:	<p>Kerto LVL laminated veneer lumber products are used in all types of construction projects, from new buildings to renovation and repair. Kerto LVL is incredibly strong and dimensionally stable. Kerto LVL derives its high strength from its homogeneous bonded structure. The wood raw material for Kerto LVL originates from sustainable northern forests. Kerto LVL structures in construction act as long-term carbon storage. The service life of Kerto LVL is considered to be as long as the lifetime of the building, providing the Kerto LVL product is installed according to instructions. For a numerical service life value, 100 years can be used.</p> <p>Kerto LVL is made of 3 mm thick rotary peeled and strength graded softwood veneers. The veneers are bonded with weather- and boil-resistant phenol formaldehyde adhesive. In S-beam and T-stud all the veneers are oriented in same direction. In Q-panel, Qp-beam, L-panel and Kate, part of the veneers are oriented in crosswise direction to enhance the transverse strength and stiffness of the products. Kerto LVL is made as continuous billet which is cut to length and sawn into LVL beams, planks or panels according to the customer's requirements. Kerto LVL products are CE marked according to the EN 14374 standard.</p> <p>Kerto LVL is the best choice for fast, light and sustainable construction. The core competence of Metsä Wood is industrial-scale manufacturing. Offsite partners of Metsä Wood develop their elements and modules using versatile Kerto LVL products and element systems.</p>
Use:	Kerto LVL can be used as beams, columns or panels in load bearing or non-load bearing structures. It is an ideal material, for example for roof, wall and floor applications. Kerto LVL can be used in whole wooden structures or together with other building materials.
Formaldehyde emissions:	Determined according to EN 717-1, the formaldehyde emitted by Kerto LVL falls far below the Class E1 requirement of ≤ 0.100 ppm and fulfils the most stringent requirements in the world (≤ 0.030 ppm). The formaldehyde emission of Kerto LVL is approximately 0.018 ppm.
Other information:	Metsä Wood Kerto LVL products do not contain more than 0.1% of any the Substances of Very High Concern (SVHC) listed on the Candidate List of the ECHA, as these substances have not been intentionally added to the products.

Product composition

	%	kg*	
Northern softwood **	93	468	veneers
Phenol formaldehyde adhesive ***	7	35	veneer bonding
Melamine formaldehyde adhesive / melamine urea formaldehyde adhesive ***	< 0.1	0.5	surface veneer scarf-joints

* The weight has been calculated for 1 m³ of Kerto LVL with weighted average density of products produced during the year of data collection

** Kerto LVL is made of spruce (*Picea abies*). The product may also contain small amounts of pine (*Pinus sylvestris*).

*** During hot pressing, the adhesive cures. Cured adhesive is inert and non-hazardous to humans and animals.

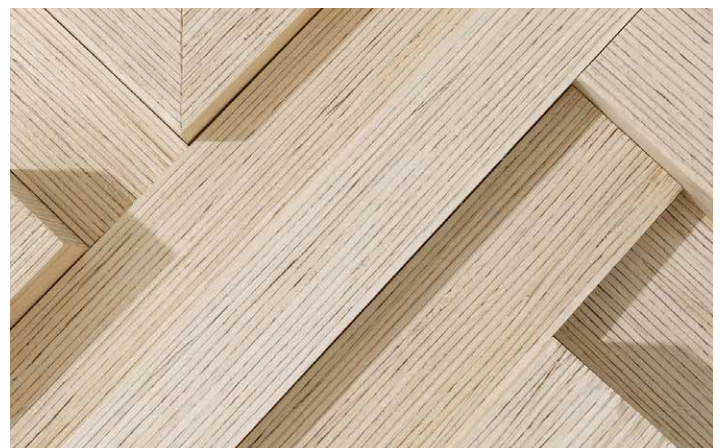

Technical information

	S-beam	Q-panel	Qp-beam	Kate	L-panel	T-stud
Thickness range (t)	21 - 75 mm	21 - 75 mm	39 - 75 mm	15 - 18 mm	21 - 75 mm	27 - 75 mm
Maximum width/height (b)	2,500 mm	2,500 mm	2,500 mm	2,500 mm	2,500 mm	200 mm
Maximum length (l)	25,000 mm	25,000 mm	25,000 mm	3,600 mm	25,000 mm	16,000 mm
Mean density (RH 65%, 20 °C)	510 kg/m ³	510 kg/m ³	510 kg/m ³	510 kg/m ³	440 kg/m ³	440 kg/m ³
Moisture content (delivered from the mill)	8 - 10%	8 - 10%	8 - 10%	8 - 10%	8 - 10%	8 - 10%
Resistance to vapour diffusion wet cup	$\mu=70$	$\mu=70$	$\mu=70$	$\mu=70$	$\mu=65$	$\mu=65$
Resistance to vapour diffusion dry cup	$\mu=200$	$\mu=200$	$\mu=200$	$\mu=200$	$\mu=180$	$\mu=180$
Thermal conductivity	$\lambda = 0.13 \text{ W/(mK)}$ (EN ISO 10456)	$\lambda = 0.13 \text{ W/(mK)}$ (EN ISO 10456)	$\lambda = 0.13 \text{ W/(mK)}$ (EN ISO 10456)	$\lambda = 0.13 \text{ W/(mK)}$ (EN ISO 10456)	$\lambda = 0.12 \text{ W/(mK)}$ (EN ISO 10456)	$\lambda = 0.12 \text{ W/(mK)}$ (EN ISO 10456)
Specific thermal capacity	$c_p = 1,880 \text{ J/(kgK)}$	$c_p = 1,880 \text{ J/(kgK)}$	$c_p = 1,880 \text{ J/(kgK)}$	$c_p = 1,880 \text{ J/(kgK)}$	$c_p = 1,880 \text{ J/(kgK)}$	$c_p = 1,880 \text{ J/(kgK)}$
Service classes	1 and 2	1 and 2	1 and 2	1 and 2	1 and 2	1 and 2

Packaging

	kg*
Wood	3.39
Plastic	0.98
Cardboard	0.15

* The average amount of packing material used to pack 1 m³ of Kerto LVL during the year of data collection

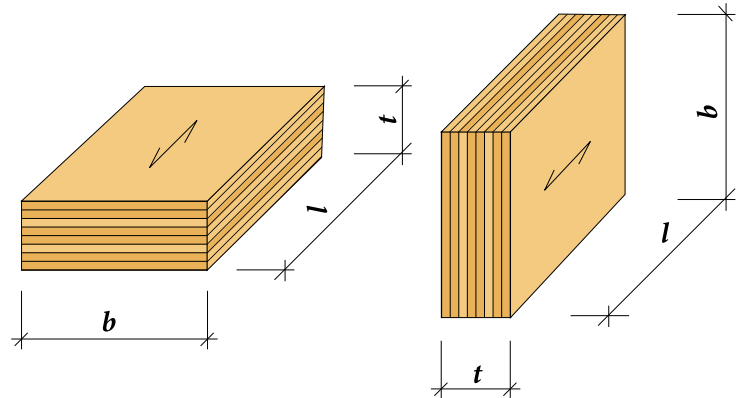

Dimensions of Kerto LVL: b = width (height), l = length, t = thickness. The arrow shows the grain direction of the surface veneer.



LCA information

Declared unit:	1 m ³ of Kerto LVL
Time representativeness:	The data for this EPD is collected from the year 2018 and covers Lohja and Punkaharju Kerto LVL mills (Finland). An average product according to the production volume of both mills has been declared. The data includes raw materials, energy consumption, water consumption, packaging, Kerto LVL products, by-products, wastes and all the related transportation. Generic data has been modelled using GaBi Databases 2021. The applied allocation (physical, economic and energy) follow EN 15804 requirements.
Database and LCA software used:	The LCA model is created using the GaBi Software and the GaBi LCI database 2020.2 Version (Year 2020) developed by Sphera.
Other information:	All relevant raw materials and energy carriers used in manufacturing have been covered in the LCA calculations. Only some label adhesives representing less than 1% in mass and environmental results shares haven't been considered (cut-off approach).
Description of system boundaries:	Cradle to gate with options, modules C1-C4, module D and modules A4 and A5 as optional have been covered.
LCA Author:	Sphera Solutions GmbH, Hauptstraße 111-113 70771 Leinfelden-Echterdingen Germany Phone +49 711 341817-0 Fax +49 711 341817-25

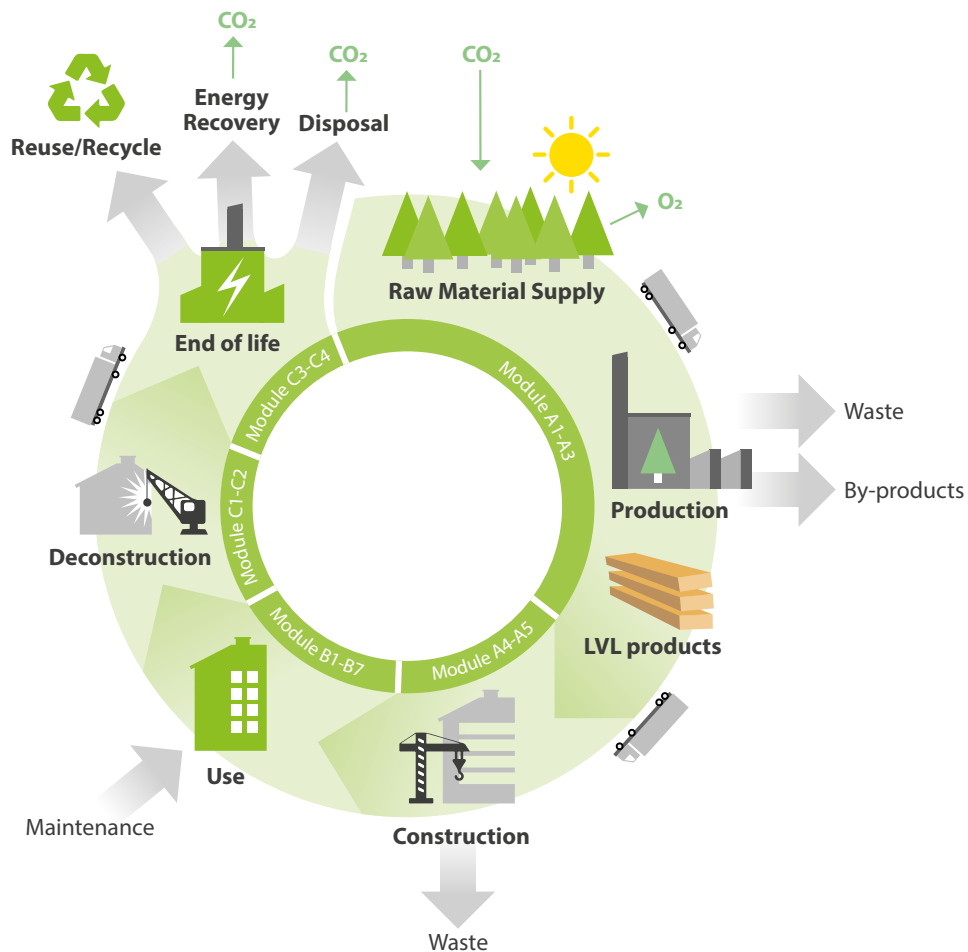

MODULES DECLARED, GEOGRAPHICAL SCOPE, SHARE OF SPECIFIC DATA (IN GWP-GHG INDICATOR) AND DATA VARIATION:

	Product stage		Construction process stage			Use stage							End of life stage				Resource recovery stage
	Raw material supply	Transport	Manufacturing	Transport	Construction installation	Use	Maintenance	Repair	Replacement	Refurbishment	Operational energy use	Operational water use	De-construction demolition	Transport	Waste processing	Disposal	Reuse-Recovery-Recycling-potential
Module	A1	A2	A3	A4	A5	B1	B2	B3	B4	B5	B6	B7	C1	C2	C3	C4	D
Modules declared	<input checked="" type="checkbox"/>	<input checked="" type="checkbox"/>	<input checked="" type="checkbox"/>	<input checked="" type="checkbox"/>	<input checked="" type="checkbox"/>	ND	ND	ND	ND	ND	ND	ND	<input checked="" type="checkbox"/>	<input checked="" type="checkbox"/>	<input checked="" type="checkbox"/>	<input checked="" type="checkbox"/>	<input checked="" type="checkbox"/>
Geography	EU-28	EU-28	FI	EU-28	EU-28	ND	ND	ND	ND	ND	ND	ND	EU-28	EU-28	EU-28	EU-28	EU-28
Specific data used	>90% for A1-A3					-	-	-	-	-	-	-	-	-	-	-	-
Variation - products	Not relevant					-	-	-	-	-	-	-	-	-	-	-	-
Variation - sites	<10% for A1-A3					-	-	-	-	-	-	-	-	-	-	-	-

: declared module
 ND: modules not declared

Product stage

A1: The raw material and supply stage covers the forestry operations, processing of raw materials, glue production, generation of electricity, steam and heat from primary resources. Metsä Wood has only one roundwood supplier, Metsä Forest, also a part of Metsä Group. All the used wood comes from certified or controlled forests. Sustainable forest use is ensured by third-party certification. Kerto LVL mills have certified PEFC and FSC Chain of Custody. Sustainably managed forests as such have no carbon emissions associated with land use change. Loss of carbon from the soil may be assumed to be negligible with no erosion.

A2: The transport includes the transportation of the raw material to the Kerto LVL mills in Lohja and Punkaharju.

A3: The manufacturing stage covers the production of Kerto LVL, by-products, packaging materials and wastes of the production process.

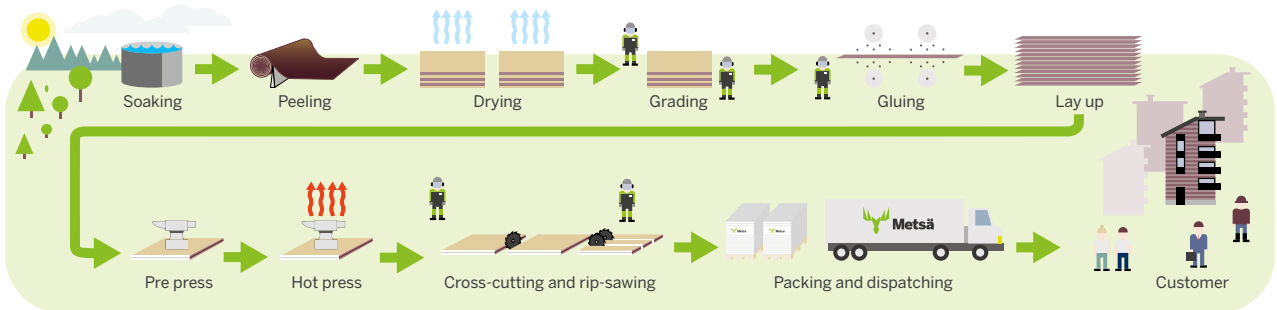

Construction process stage

A4: The transport stage of the construction process includes the average transportation of Kerto LVL to European customers. The distance used in this EPD has been determined as a weighted average according to delivered volumes for certain market areas on the year of data collection.

A5: The construction installation phase includes the manufacturing, packaging and transportation of the installation losses, as well as the used energy and auxiliary materials (metallic screws) to install the product. The end-of-life treatment of the losses, the product packaging and the installation auxiliary materials related to installation are also accounted for under this module.

Use stage

B1-B7: Kerto LVL structures are designed to last for the whole lifetime of the building. There are no environmental impacts caused during this time.

End of life stages

C1-C4: Kerto LVL products can have several end of life scenarios options. The alternatives for end of life options may vary according to available technologies, market specific waste legislation, local waste handling systems and consumer behaviour.

In this EPD, two scenarios are covered: Scenario 1 where the product is considered a secondary fuel for a next system and Scenario 2 where the product is recycled in a next system substituting a construction product. For both declared end-of-life scenarios, energy consumed for removing auxiliary installation materials (e.g. screws) in module C1, as well as the transportation of the product to the end-of-life processing sites (50 km) in module C2 have been considered.

The emission of biogenic CO₂ bound in the product is accounted for Module C3 for both scenarios, where the end-of-waste status is reached. At this stage also energy consumption to prepare the products for their processing by the next system is included.

D: This module covers any credits and/or loads beyond the system boundaries. Credits from the burning of packaging materials during their waste treatment in module A5 are accounted for this module. For end-of-life Scenario 1, both emissions of the incineration process where the product is used as a secondary fuel as well as the potential credits (energy substitution) are declared in module D. For Scenario 2, the virgin material substitution of reusing the product in a next system is accounted for this module as well.

Kerto LVL as carbon storage

One of the most important ways to mitigate climate change is to reduce dependence on fossil resources. Wood is a renewable, recyclable and reusable building material. Above all, wood stores carbon. As the building sector contributes up to 30% of global annual greenhouse gas emissions, it plays a vital role in combatting climate change. Wood construction is a part of the solution. The long service life of Kerto LVL products ensures long carbon storage times. Every tree used in construction stores carbon and makes room for new seedlings – a new carbon sink.

The key to sustainable wood products is to use only wood from sustainable sources. Most of the wood Metsä Group uses comes from family-owned forests. All the used wood is traceable and comes from certified or controlled forests. Metsä Group's wood tracing systems are certified and verified according to PEFC and FSC Chain of Custody requirements. Efficient carbon sink forests are achieved by sustainable forest and nature management. Good forest management ensures the health and good growth of forests. In addition, thinnings make room for the highest quality trees to grow stouter. These best quality trees are raw material for engineered wood products. Sustainable forestry always includes forest regeneration – each felled tree is replaced with four seedlings. In Finland forests grow more than they are used and the amount of wood in forests increases every year.

Carbon stored in Kerto LVL is 783 kg CO₂ eq/m³. As long as Kerto LVL product is in use, carbon stays stored. Reuse and recycling ensure prolonged carbon storage. Once the material is disposed, biogenic carbon is released back to the atmosphere. The released carbon dioxide is absorbed by trees from the atmosphere through the photosynthesis process. Growing trees utilise the energy of sunlight and convert absorbed carbon dioxide and water into carbohydrates. This way trees function as a carbon sink. When energy recovery is used as the final disposal method for Kerto LVL material, renewable wood material is substituting fossil fuels in energy production.

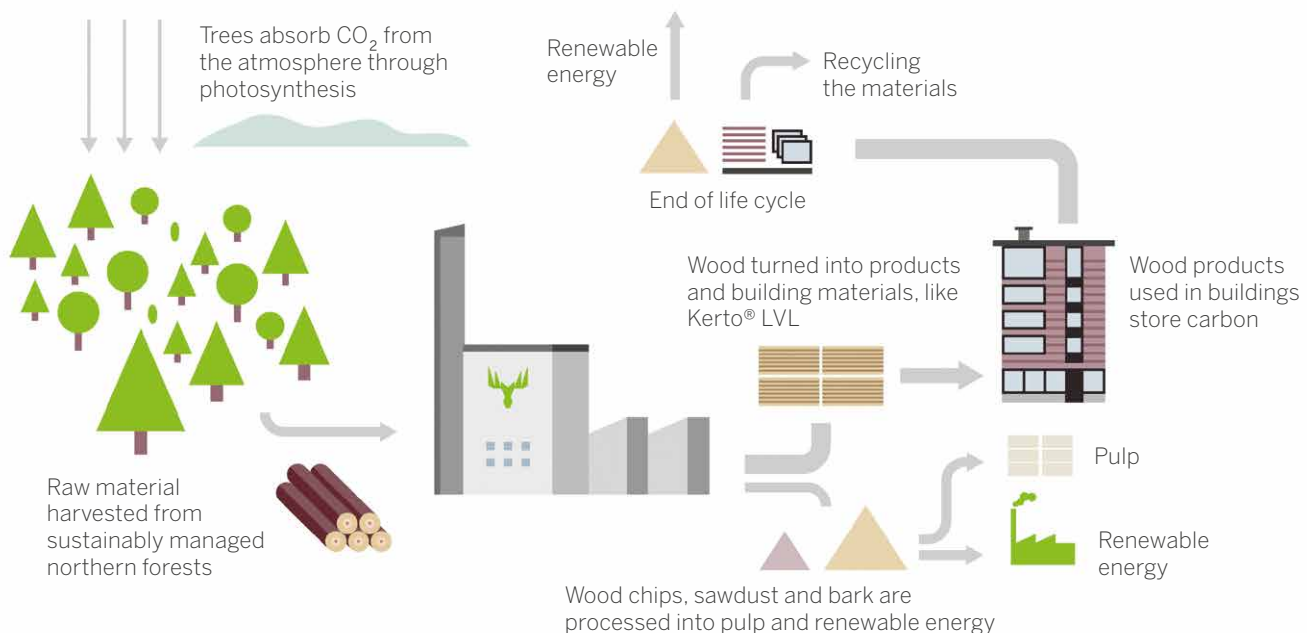

Environmental Information

1 CORE ENVIRONMENTAL IMPACT INDICATORS - 1 m³ OF KERTO LVL

Indicator	Unit	A1-A3	A4	A5
Global Warming Potential - total (GWP-total)*	kg CO ₂ eq.	-382	19.8	37.5
Global Warming Potential - fossil fuels (GWP-fossil)	kg CO ₂ eq.	280	19.7	20.3
Global Warming Potential - biogenic (GWP-biogenic)*	kg CO ₂ eq.	-663	5.14 · 10 ⁻²	17.1
Global Warming Potential - land use and land use change (GWP-luluc)	kg CO ₂ eq.	0.353	0.114	1.84 · 10 ⁻²
Depletion potential of the stratospheric ozone layer (ODP)	kg CFC-11 eq.	2.57 · 10 ⁻¹²	2.22 · 10 ⁻¹⁵	6.42 · 10 ⁻¹⁴
Acidification potential, Accumulated Exceedance (AP)	mol H ⁺ eq.	1.08	0.233	0.123
Eutrophication potential - freshwater (EP-freshwater)	kg P eq.	4.92 · 10 ⁻⁴	4.40 · 10 ⁻⁵	3.23 · 10 ⁻⁵
Eutrophication potential - marine (EP-marine)	kg N eq.	0.388	5.97 · 10 ⁻²	3.90 · 10 ⁻²
Eutrophication potential - terrestrial (EP-terrestrial)	mol N eq.	4.23	0.658	0.429
Photochemical Ozone Creation Potential (POCP)	kg NMVOC eq.	1.14	0.167	0.116
Abiotic depletion potential - fossil resources (ADPF)	MJ	1.50 · 10 ⁴	256	568
Abiotic depletion potential - non-fossil resources (ADPE)	kg Sb eq.	2.43 · 10 ⁻⁵	1.15 · 10 ⁻⁶	1.82 · 10 ⁻⁴
Water (user) deprivation potential (WDP)	m ³ world equiv.	-18.2	0.136	-2.38

* A1: biogenic carbon storage in wood: -783 kg CO₂ eq

SCENARIO 1: INCINERATION AS SECONDARY FUEL

Indicator	Unit	C1	C2	C3	C4	D
Global Warming Potential - total (GWP-total)	kg CO ₂ eq.	2.00 · 10 ⁻²	1.70	785	0	-330
Global Warming Potential - fossil fuels (GWP-fossil)	kg CO ₂ eq.	1.99 · 10 ⁻²	1.67	0.830	0	-422
Global Warming Potential - biogenic (GWP-biogenic)	kg CO ₂ eq.	6.62 · 10 ⁻⁵	1.25 · 10 ⁻²	784	0	92.9
Global Warming Potential - land use and land use change (GWP-luluc)	kg CO ₂ eq.	2.88 · 10 ⁻⁵	1.35 · 10 ⁻²	1.20 · 10 ⁻³	0	-0.376
Depletion potential of the stratospheric ozone layer (ODP)	kg CFC-11 eq.	4.37 · 10 ⁻¹⁶	3.06 · 10 ⁻¹⁶	1.83 · 10 ⁻¹⁴	0	-5.65 · 10 ⁻¹²
Acidification potential, Accumulated Exceedance (AP)	mol H ⁺ eq.	4.39 · 10 ⁻⁵	1.94 · 10 ⁻³	1.83 · 10 ⁻³	0	0.251
Eutrophication potential - freshwater (EP-freshwater)	kg P eq.	5.31 · 10 ⁻⁸	5.08 · 10 ⁻⁶	2.22 · 10 ⁻⁶	0	-6.91 · 10 ⁻⁴
Eutrophication potential - marine (EP-marine)	kg N eq.	9.74 · 10 ⁻⁶	5.97 · 10 ⁻⁴	4.07 · 10 ⁻⁴	0	6.72 · 10 ⁻²
Eutrophication potential - terrestrial (EP-terrestrial)	mol N eq.	1.02 · 10 ⁻⁴	7.08 · 10 ⁻³	4.28 · 10 ⁻³	0	0.812
Photochemical Ozone Creation Potential (POCP)	kg NMVOC eq.	2.67 · 10 ⁻⁵	1.60 · 10 ⁻³	1.12 · 10 ⁻³	0	0.289
Abiotic depletion potential - fossil resources (ADPF)	MJ	0.349	22.3	14.6	0	-8.03 · 10 ³
Abiotic depletion potential - non-fossil resources (ADPE)	kg Sb eq.	5.75 · 10 ⁻⁹	1.35 · 10 ⁻⁷	2.40 · 10 ⁻⁷	0	-8.51 · 10 ⁻⁵
Water (user) deprivation potential (WDP)	m ³ world equiv.	4.33 · 10 ⁻³	1.63 · 10 ⁻²	0.181	0	-22.6

SCENARIO 2: RECYCLING

Indicator	Unit	C1	C2	C3	C4	D
Global Warming Potential - total (GWP-total)	kg CO ₂ eq.	2.00 · 10 ⁻²	1.70	785	0	809
Global Warming Potential - fossil fuels (GWP-fossil)	kg CO ₂ eq.	1.99 · 10 ⁻²	1.67	0.830	0	-46.5
Global Warming Potential - biogenic (GWP-biogenic)	kg CO ₂ eq.	6.62 · 10 ⁻⁵	1.25 · 10 ⁻²	784	0	856
Global Warming Potential - land use and land use change (GWP-luluc)	kg CO ₂ eq.	2.88 · 10 ⁻⁵	1.35 · 10 ⁻²	1.20 · 10 ⁻³	0	-9.15 · 10 ⁻²
Depletion potential of the stratospheric ozone layer (ODP)	kg CFC-11 eq.	4.37 · 10 ⁻¹⁶	3.06 · 10 ⁻¹⁶	1.83 · 10 ⁻¹⁴	0	-3.57 · 10 ⁻¹³
Acidification potential, Accumulated Exceedance (AP)	mol H ⁺ eq.	4.39 · 10 ⁻⁵	1.94 · 10 ⁻³	1.83 · 10 ⁻³	0	-0.193
Eutrophication potential - freshwater (EP-freshwater)	kg P eq.	5.31 · 10 ⁻⁸	5.08 · 10 ⁻⁶	2.22 · 10 ⁻⁶	0	-9.34 · 10 ⁻⁵
Eutrophication potential - marine (EP-marine)	kg N eq.	9.74 · 10 ⁻⁶	5.97 · 10 ⁻⁴	4.07 · 10 ⁻⁴	0	-8.27 · 10 ⁻²
Eutrophication potential - terrestrial (EP-terrestrial)	mol N eq.	1.02 · 10 ⁻⁴	7.08 · 10 ⁻³	4.28 · 10 ⁻³	0	-0.908
Photochemical Ozone Creation Potential (POCP)	kg NMVOC eq.	2.67 · 10 ⁻⁵	1.60 · 10 ⁻³	1.12 · 10 ⁻³	0	-0.239
Abiotic depletion potential - fossil resources (ADPF)	MJ	0.349	22.3	14.6	0	-689
Abiotic depletion potential - non-fossil resources (ADPE)	kg Sb eq.	5.75 · 10 ⁻⁹	1.35 · 10 ⁻⁷	2.40 · 10 ⁻⁷	0	-6.60 · 10 ⁻⁶
Water (user) deprivation potential (WDP)	m ³ world equiv.	4.33 · 10 ⁻³	1.63 · 10 ⁻²	0.181	0	-3.09

Environmental Information

2 INDICATORS DESCRIBING RESOURCE USE - 1 m³ OF KERTO LVL

Indicator	Unit	A1-A3	A4	A5
Use of renewable primary energy as energy carrier (PERE)	MJ	3.31 · 10 ³	10.7	325
Use of renewable primary energy resources used as raw materials (PERM)	MJ	9.62 · 10 ³	0	-66.9
Total use of renewable primary energy (PERT)	MJ	1.30 · 10 ⁴	10.7	258
Use of non-renewable primary energy as energy carrier (PENRE)	MJ	1.44 · 10 ⁴	256	612
Use of non-renewable primary energy resources used as raw materials (PENRM)	MJ	547	0	-44.3
Total use of non-renewable primary energy resource (PENRT)	MJ	1.50 · 10 ⁴	256	568
Use of secondary material (SM)	kg	0	0	0
Use of renewable secondary fuels (RSF)	MJ	0	0	0
Use of non-renewable secondary fuels (NRSF)	MJ	0	0	0
Net use of fresh water (FW)	m ³	1.47	1.26 · 10 ⁻²	0.113

SCENARIO 1: INCINERATION AS SECONDARY FUEL

Indicator	Unit	C1	C2	C3	C4	D
Use of renewable primary energy as energy carrier (PERE)	MJ	0.155	21.2	1.44 · 10 ³	0	-2.01 · 10 ³
Use of renewable primary energy resources used as raw materials (PERM)	MJ	0	0	-9.56 · 10 ³	0	0
Total use of renewable primary energy (PERT)	MJ	0.155	21.2	-8.12 · 10 ³	0	-2.01 · 10 ³
Use of non-renewable primary energy as energy carrier (PENRE)	MJ	0.349	22.4	518	0	-8.03 · 10 ³
Use of non-renewable primary energy resources used as raw materials (PENRM)	MJ	0	0	-503	0	0
Total use of non-renewable primary energy resource (PENRT)	MJ	0.349	22.4	14.6	0	-8.03 · 10 ³
Use of secondary material (SM)	kg	0	0	0	0	0
Use of renewable secondary fuels (RSF)	MJ	0	0	0	0	0
Use of non-renewable secondary fuels (NRSF)	MJ	0	0	0	0	0
Net use of fresh water (FW)	m ³	1.79 · 10 ⁻⁴	1.50 · 10 ⁻³	7.48 · 10 ⁻³	0	-1.54

SCENARIO 2: RECYCLING

Indicator	Unit	C1	C2	C3	C4	D
Use of renewable primary energy as energy carrier (PERE)	MJ	0.155	21.2	1.44 · 10 ³	0	-9.11 · 10 ³
Use of renewable primary energy resources used as raw materials (PERM)	MJ	0	0	-9.56 · 10 ³	0	0
Total use of renewable primary energy (PERT)	MJ	0.155	21.2	-8.12 · 10 ³	0	-9.11 · 10 ³
Use of non-renewable primary energy as energy carrier (PENRE)	MJ	0.349	22.4	518	0	-689
Use of non-renewable primary energy resources used as raw materials (PENRM)	MJ	0	0	-503	0	0
Total use of non-renewable primary energy resource (PENRT)	MJ	0.349	22.4	14.6	0	-689
Use of secondary material (SM)	kg	0	0	0	0	0
Use of renewable secondary fuels (RSF)	MJ	0	0	0	0	0
Use of non-renewable secondary fuels (NRSF)	MJ	0	0	0	0	0
Net use of fresh water (FW)	m ³	1.79 · 10 ⁻⁴	1.50 · 10 ⁻³	7.48 · 10 ⁻³	0	-0.145

Environmental Information

3 ENVIRONMENTAL INFORMATION DESCRIBING WASTE CATEGORIES AND OUTPUT FLOWS - 1 m³ OF KERTO LVL

Indicator	Unit	A1-A3	A4	A5
Hazardous waste disposed (HWD)	kg	$3.02 \cdot 10^{-5}$	$8.71 \cdot 10^{-6}$	$1.22 \cdot 10^{-6}$
Non-hazardous waste disposed (NHWD)	kg	1.55	$3.57 \cdot 10^{-2}$	0.937
Radioactive waste disposed (RWD)	kg	0.416	$3.09 \cdot 10^{-4}$	$1.84 \cdot 10^{-2}$
Components for re-use (CRU)	kg	0	0	0
Materials for recycling (MFR)	kg	0	0	0
Materials for energy recovery (MER)	kg	0	0	0
Exported electrical energy (EEE)	MJ	0	0	123
Exported thermal energy (EET)	MJ	0	0	173

SCENARIO 1: INCINERATION AS SECONDARY FUEL

Indicator	Unit	C1	C2	C3	C4	D
Hazardous waste disposed (HWD)	kg	$1.45 \cdot 10^{-10}$	$1.03 \cdot 10^{-6}$	$6.04 \cdot 10^{-9}$	0	$-2.69 \cdot 10^{-6}$
Non-hazardous waste disposed (NHWD)	kg	$2.48 \cdot 10^{-4}$	$3.54 \cdot 10^{-3}$	$1.04 \cdot 10^{-2}$	0	6.34
Radioactive waste disposed (RWD)	kg	$5.30 \cdot 10^{-5}$	$4.12 \cdot 10^{-5}$	$2.21 \cdot 10^{-3}$	0	-0.687
Components for re-use (CRU)	kg	0	0	0	0	0
Materials for recycling (MFR)	kg	0	0	0.998	0	0
Materials for energy recovery (MER)	kg	0	0	503	0	0
Exported electrical energy (EEE)	MJ	0	0	0	0	0
Exported thermal energy (EET)	MJ	0	0	0	0	0

SCENARIO 2: RECYCLING

Indicator	Unit	C1	C2	C3	C4	D
Hazardous waste disposed (HWD)	kg	$1.45 \cdot 10^{-10}$	$1.03 \cdot 10^{-6}$	$6.04 \cdot 10^{-9}$	0	$-8.09 \cdot 10^{-6}$
Non-hazardous waste disposed (NHWD)	kg	$2.48 \cdot 10^{-4}$	$3.54 \cdot 10^{-3}$	$1.04 \cdot 10^{-2}$	0	-0.314
Radioactive waste disposed (RWD)	kg	$5.30 \cdot 10^{-5}$	$4.12 \cdot 10^{-5}$	$2.21 \cdot 10^{-3}$	0	$-3.88 \cdot 10^{-2}$
Components for re-use (CRU)	kg	0	0	0	0	0
Materials for recycling (MFR)	kg	0	0	504	0	0
Materials for energy recovery (MER)	kg	0	0	0	0	0
Exported electrical energy (EEE)	MJ	0	0	0	0	0
Exported thermal energy (EET)	MJ	0	0	0	0	0

Environmental Information

4 BIOGENIC CARBON CONTENT OF PRODUCT AND PACKAGING - 1 m³ OF KERTO LVL

Indicator	Unit	A1-A3	A4	A5
Biogenic carbon content in accompanying packaging	kg	1.39	0	0
Biogenic carbon content in product	kg	214	0	0

SCENARIO 1: INCINERATION AS SECONDARY FUEL

Indicator	Unit	C1	C2	C3	C4	D
Biogenic carbon content in accompanying packaging	kg	0	0	0	0	0
Biogenic carbon content in product	kg	0	0	0	0	0

SCENARIO 2: RECYCLING

Indicator	Unit	C1	C2	C3	C4	D
Biogenic carbon content in accompanying packaging	kg	0	0	0	0	0
Biogenic carbon content in product	kg	0	0	0	0	0

5 SUPPLEMENTARY INDICATOR FOR CLIMATE IMPACT - 1 m³ OF KERTO LVL

Indicator	Unit	A1-A3	A4	A5
Global Warming Potential (GWP-GHG) IPCC AR5 GWP100, excl biogenic carbon	kg CO ₂ eq.	276	19.5	19.9

SCENARIO 1: INCINERATION AS SECONDARY FUEL

Indicator	Unit	C1	C2	C3	C4	D
Global Warming Potential (GWP-GHG) IPCC AR5 GWP100, excl biogenic carbon	kg CO ₂ eq.	1.97 · 10 ⁻²	1.66	0.825	0	-421

SCENARIO 2: RECYCLING

Indicator	Unit	C1	C2	C3	C4	D
Global Warming Potential (GWP-GHG) IPCC AR5 GWP100, excl biogenic carbon	kg CO ₂ eq.	1.97 · 10 ⁻²	1.66	0.825	0	-46.0

References

EN ISO 14025	EN ISO 14025:2011 Environmental labels and declarations - Type III environmental declarations - Principles and procedures (ISO 14025:2006)
EN ISO 14040+A1	EN ISO 14040:2006 + A1:2020 Environmental management - Life cycle assessment - Principles and framework (ISO 14040:2006 + Amd 1:2020)
EN ISO 14044+A1+A2	EN ISO 14044:2006 + A1:2018 + A2:2020 Environmental management - Life cycle assessment - Requirements and guidelines (ISO 14044:2006 + Amd 1:2017 + Amd 2:2020)
EN 15804+A2	EN 15804:2012 + A2:2019 Sustainability of construction works –Sustainability of construction works –Core rules for the product category of construction products.
EN 15942	EN 15942:2012 Sustainability of construction works - Environmental product declarations - Communication format business-to-business
EN 16485	EN 16485:2014 Round and sawn timber. Environmental product declarations. Product category rules for wood and wood-based products for use in construction.
EPD® SYSTEM 2019	The International EPD System. Product Category Rules (PCR): Construction Products (PCR 2019:14, Version 1.1). The International EPD System.
EPD® SYSTEM 2019	The International EPD System. (2019a, December 20). Product Category Rules According to ISO 14025:2006 for Construction Products.
EPD® SYSTEM 2019	The International EPD System. (2019b, December 20). Complementary Product Category Rules According to ISO 14025:2006 for Wood and wood-based products.